

Technology that saves lives

Releasing Module

GSA-REL

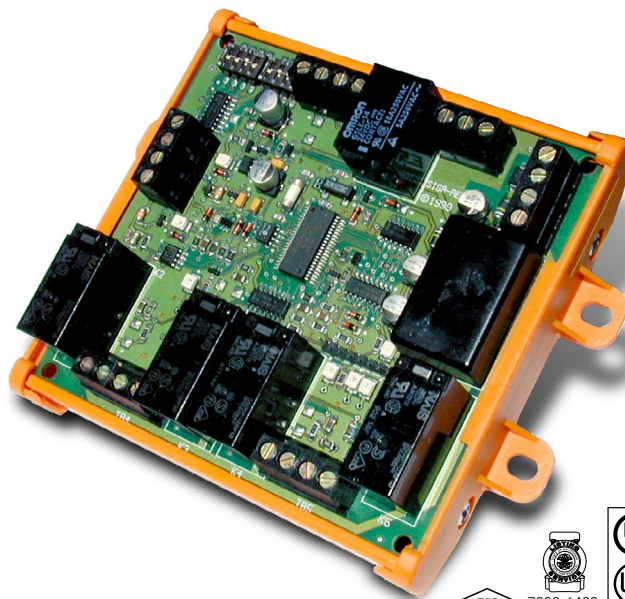

Overview

The GSA-REL is an analog addressable module that communicates directly with the fire alarm panel Signature loop controller. The GSA-REL controls sprinkler, pre-action and deluge systems, and may also be used to release extinguishing agents such as CO₂, Halon, or foam. The module is easily configured in the field and offers a wide range of options that ensure dependable service, while preventing the unnecessary release of extinguishing agent.

In addition to being an intelligent network component, the GSA-REL interfaces with a number of conventional devices. These provide manual actuation of abort, release, and service disconnect functions. Together with the GSA-REL, they comprise a complete fire suppression package. There is no need for a separate releasing panel because the GSA-REL takes full advantage of the existing control panel communications infrastructure. This ensures low-cost installations with all the benefits of Signature Series analog initiation and control.

Seven on-board circuits provide added flexibility. Each GSA-REL hosts:

- Two supervised Class B release circuits
- Two supervised Class B pre-release NACs
- One supervised Class B manual release input circuit (latching)
- One supervised Class B abort circuit for normally-open abort switch (non-latching)
- One first alarm output relay (Form C contact)

The GSA-REL also includes a series of built-in timers that determine the duration of abort routines and release sequences. These timers are easily configured in the field and provide a highly flexible range of options.

Standard Features

- **Ideal for sprinkler, pre-action and deluge systems**
Suitable a wide range of sprinkler applications and extinguishing agents such as CO₂ and Halon.
- **Built-in timers**
Selectable durations for abort, manual, and automatic delays.
- **Four abort modes**
Field-configurable abort routines determine how the timers operate when the abort function is initiated.
- **Supervised circuitry you can rely on**
Two Class B release circuits and two pre-release circuits provided.
- **Manual operation keeps ultimate control in plain view**
The GSA-REL features a manual release input circuit as well as a manual abort input circuit.
- **Fully automated response leaves nothing to chance**
This module's Form C relay is ideal for room preparation routines.
- **Automatic device mapping simplifies installation**
Signature modules transmit directly to the loop controller their circuit locations with respect to other Signature devices on the wire loop.

Application

Understanding fire suppression

Fire suppression today is an important part of a growing number of life safety installations. With an ever-increasing reliance on mission-critical computer systems and record high capital investment in high-tech production facilities, businesses large and small are looking for a means of protecting their investments and ensuring a fire won't cripple their operations.

While fire detection remains the first line of defense against the risks of fire to people, building owners are looking to fire suppression as a means of protecting their property and assets.

But it's a well known fact that fire suppression is a double-edged sword: water can snuff out a mission-critical computer system as easily as it can a fire. Alternatives to water, including carbon dioxide and other extinguishing agents can endanger lives, while the release of even the most inert extinguishing agents can disrupt operations and cost millions of dollars in down-time and lost production.

A primary goal of any fire suppression system is to prevent the release of extinguishing agent unless it is absolutely necessary. There is no margin for error. But no matter what measures are taken to prevent the unwanted release of extinguishing agent, the fact remains that no suppression system is any better than the detectors it relies on for input. The foundation of an effective suppression system, therefore, rests firmly on the quality and reliability of its smoke detectors.

Signature Series detectors form an integral part of the suppression system built around the GSA-REL releasing module. These detectors provide unsurpassed reliability and immunity from false alarms. The GSA-REL is engineered to the same exacting standards of quality and performance. With a robust set of features designed to eliminate any unwanted release of extinguishing agent, the GSA-REL provides all the benefits of a dedicated releasing panel without the extra expense, and equally important, all the proven advantages of the Signature Series family of products.

Understanding the GSA-REL

The GSA-REL Releasing Module is a network component that provides control for fire suppression routines. It fulfills much the same purpose as a standalone releasing panel, but supports Signature Series detectors as an integral part of the suppression system. The GSA-REL is easy to set up and accepts programming via the control panel's SDU Rules Editor.

The diagram below represents typical application of the GSA-REL. The explanations that follow summarize each element of the module.

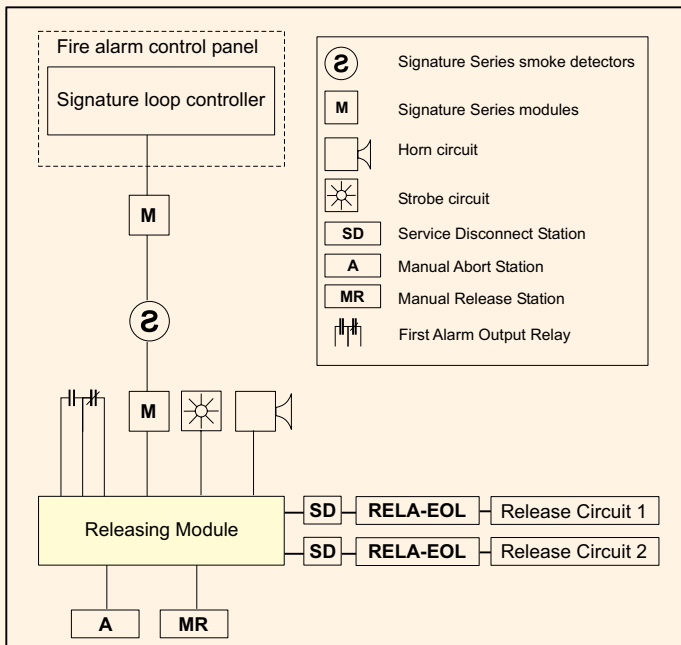

Release Circuits 1 & 2 **Release Circuits.** The GSA-REL includes two supervised release circuits, each of which provides fire suppression control to different areas of a protected space. The releasing circuits actuate solenoids on the suppression agent tanks according to pre-defined release routines. These solenoids release the agent into the protected area. Both circuits operate together.

First Alarm Relay. This on-board relay provides a Form C contact that activates at the first alarm input or manual release. The relay is typically used for room preparation such as controlling fans and dampers in advance of the release of suppression agent.

Pre-release. Pre-release circuits are used to provide power to notification appliances located within the protected area. Two supervised pre-release circuits are provided: one (steady) for visual notification appliances, and one (pulsed) for audible notification appliances. The pre-release circuits activate with the start of the automatic delay timer.

Manual Release. The manual release circuit is used to activate the suppression system by means of a connected normally-open release station. This initiates the manual release sequence according to a pre-defined routine. The manual release circuit is supervised and latching. Input from this circuit is processed at the module – communication with the control panel is not necessary.

Abort. The abort circuit is used to prevent the release of agent into the protected area after the release sequence has begun, but before the automatic delay timer expires. A connected normally-open release station provides manual control over this circuit. The abort circuit is supervised and non-latching.

Service Disconnect. The service disconnect switch is used to temporarily disable the fire suppression system. There is no dedicated circuit for this switch. Instead, it is installed on both release circuits between the GSA-REL and the RELA-EOL end-of-line relay. Opening the Service Disconnect Switch allows the fire alarm system to be tested without activating the fire suppression system. The operation of this switch causes a trouble signal at the control panel.

Data. The Signature data circuit provides an input and an output to the data loop that communicates with the Signature loop controller at the control panel. The GSA-REL resides on the same data loop as the Signature Series detectors that initiate the automatic release sequence. This close association offers the most reliable performance and ensures compliance with prevailing life safety codes.

Power. The GSA-REL requires 24 Vdc (power limited). See the specification table for details.

Operation

The GSA-REL has several built-in safeguards to prevent the unwanted release of extinguishing agent. All release sequences are subject to configurable delay timers that provide the opportunity for an occupant of the area to manually abort the release sequence. If no abort signal is received before the delay timer expires, the suppression agent is released.

The GSA-REL includes three delay timers: one for manual release sequences (up to 30 seconds); one for automatic release sequences (up to 50 seconds); and one for abort sequences (10 seconds).

Normal State

In its normal operating state the GSA-REL supervises both of its release circuits and both of its pre-release NAC circuits for faults. Should a short or open occur on any of these circuits, a Trouble condition is reported to the control panel.

A trouble condition on any of these circuits may prevent the operation of that circuit, but it won't inhibit the operation of any other fault-free circuit.

Manual Release Sequence

The operation of a manual release station initiates the manual release sequence. The diagram below outlines the manual release sequence.

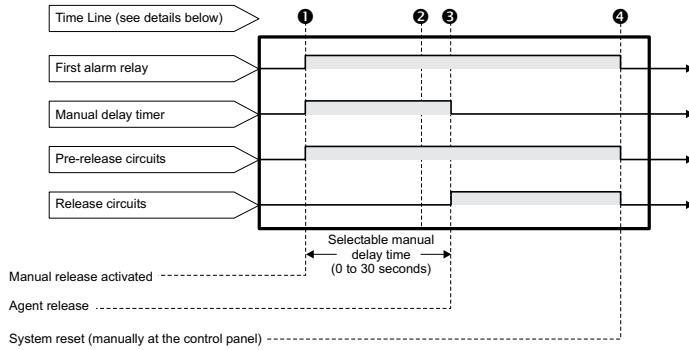

Note: A manual release sequence cannot be aborted.

Manual Release Time Line

- 1 An active manual release station disables automatic operation and the abort function and simultaneously activates the:
 - Manual delay timer
 - Pre-release circuit
 - Pre-release strobe circuit (steady On)
 - Pre-release horn circuit (60 pulses per minute)
- 2 Ten seconds before the expiration of the manual delay timer, the pre-release horn changes from 60 pulses per minute to steady On.
- 3 The manual delay timer expires and the release circuits activate.
- 4 A manual reset at the fire alarm control panel deactivates the release solenoids and the Releasing Module returns to the normal state.

Note: Misapplication of the GSA-REL can have serious consequences. Descriptions provided here are for information only, are subject to change, and should not be used as a guide to field installation of equipment. Always consult the GSA-REL installation manual when setting up or configuring this component.

Automatic Release Sequence

The automatic release sequence requires an AND group (cross zone) or a matrix group (counting zone). AND groups and matrix groups require fire alarm signals from designated Signature Series devices. These logic groups are programmable through a laptop computer and the System Definition Utility (SDU).

Note: MIR2 systems do not support matrix groups. See *Programming the GSA-REL* for AND group rules. To create AND groups and matrix groups, see the *System Programming Manual* and the *SDU Online Help* for your system.

The diagram below outlines the automatic release sequence.

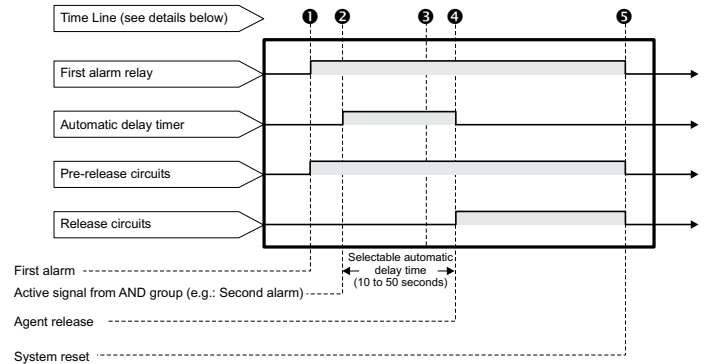

Automatic Release Time Line

- 1 A detector signals the first alarm. This event simultaneously activates the:
 - First alarm relay
 - Pre-release strobe circuit (steady On)
 - Pre-release horn circuit (15 pulses per minute)
- 2 A detector in the protected area signals a second alarm and meets the AND group conditions.* The automatic delay timer then starts its countdown and the pre-release horn circuit changes to 60 pulses per minute.
 - * AND group and matrix group conditions depend on programming.
- 3 10 seconds before the automatic delay timer expires, the pre-release (horn) circuit changes to steady On.
- 4 The automatic delay timer expires and the release circuits activate.
- 5 A manual reset at the fire alarm control panel deactivates the release solenoids and the Releasing Module returns to the normal state.

Abort Sequences

The GSA-REL provides four abort modes. Aborts do not terminate the release of fire suppression agents. They merely offer a limited extension of the automatic timer delay period.

Abort Mode 1 (factory default)

If the abort is initiated before the automatic time delay expires, it will prevent the releasing action. The automatic delay timer will continue to run while the abort is active. When the abort switch is restored, the release will occur with the expiration of the automatic delay timer or the abort delay timer, whichever occurs last.

Abort Mode 2

If the abort is initiated before the automatic time delay expires, it will prevent the releasing action. The automatic delay timer will stop running. When the abort switch is restored, the automatic delay timer will continue from the stop point and the release will occur with the expiration of the timer.

Abort Mode 3

Industrial Risk Insurers (IRI) Mode: To be recognized as valid, the abort must be active when the second alarm is received. When the abort switch is restored, the release will occur with the expiration of the abort delay timer (set for 10 sec).

Abort Mode 4

International applications: If the abort is initiated before the automatic time delay expires, it will prevent the releasing action. The automatic delay timer will stop running. When the abort switch is restored, the automatic delay timer will reset and commence time from $t = 0$. The release will occur with the expiration of the timer setting minus 10 seconds.

Compatibility

Sprinkler systems

The GSA-REL works with two types of sprinkler systems: deluge and pre-action. The primary difference between both systems is the type of sprinkler head (or nozzle) that terminates the pipes. Table 1-1 outlines the Factory Mutual Research Corporation (FMRC) requirements for deluge and pre-action systems.

FM approval requirements for deluge and pre-action sprinkler systems

Standby operation	90 hours
Alarm operation	10 minutes
NFPA style	Class A (Style D or E) or Class A (Style 2, 5, 6, or 7)
FMRC documentation	FMRC Approval Guide (Volume 1)

Deluge sprinkler systems

In Deluge sprinkler systems, open-valve sprinkler heads terminate pipes connected to a water supply controlled by a single valve. When the system detects a fire it automatically opens the valve to allow the waterflow through all of the sprinkler heads. Deluge sprinklers are useful for applications that require the simultaneous discharge of water through every sprinkler.

The following fire detection systems meet FMRC requirements for deluge systems:

- Wet pilot sprinkler line
- Dry pilot sprinkler line
- Hydraulic rate-of-rise
- Pneumatic rate-of-rise
- Electric

Pre-action sprinkler systems

In Pre-action sprinkler systems, closed-valve sprinkler heads terminate pipes connected directly to a water supply. The water supply is usually in the same area as the sprinklers and the pipes are supervised for air pressure. Pre-action sprinklers are useful where it is important to prevent the accidental discharge of water.

The following fire detection systems meet FMRC requirements for pre-action systems:

- Hydraulic rate-of-rise
- Pneumatic rate-of-rise
- Electric

Automatic fire extinguishing systems

Automatic fire extinguishing systems automatically detect and extinguish fires. They require no manual input because detectors automatically activate releasing solenoids or sprinkler valves. The table below provides a list of the fire suppression agents and the applicable NFPA documents.

Fire suppression agents and NFPA documentation

Agent	NFPA documentation
Low-expansion foam	NFPA 11
Medium- and high-expansion foam	NFPA 11A
CO ₂	NFPA 12
Sprinklers	NFPA 13
Water spray	NFPA 15
Foam-water	NFPA 16
Dry chemicals	NFPA 17

The table below outlines the FMRC requirements for automatic fire extinguishing systems.

FM approval requirements for automatic fire extinguishing systems

Standby operation	24 hours
Alarm operation	10 minutes
NFPA style	B or D
FMRC documentation	FMRC Approval Guide (Volume 1)

Warning! Improper applications of fire suppression agents can lead to property damage, injury, or loss of life. Consult the applicable NFPA documents and the authority having jurisdiction (AHJ) for more information.

Compatible panels. The GSA-REL is compatible with VS Series and VM Series fire alarm control panels. You may install the GSA-REL in any of the following enclosures:

- 2-WB(X) series
- 2-CAB series
- 3-CAB series
- RACCR series
- APS6A
- APS10A
- MFC-A

Note: Maintain a 1-inch (25.4 mm) minimum clearance all around the GSA-REL. The clearance space must also comply with the National Electrical Code.

Power supplies. The GSA-REL is compatible with the following power supplies:

- 2-PPS(-220)
- 2-PPS/6A(-220)
- MIRBPSxA*
- APSxA*
- SIGA-APS(-220)
- MIRBPSx*, APSxA

*Not compatible with FMRC sprinkler applications that require 90 hours of standby.

Solenoid polarizing relays. Use the RELA-EOL with the GSA-REL. For more information, see the RELA-EOL installation sheet.

Abort stations. The GSA-REL is only compatible with normally-open, momentary-action abort stations. Abort stations must be listed with the appropriate agencies in your area. See *Listing agencies*.

Service disconnect stations. The GSA-REL is only compatible with service disconnect stations that are normally-closed (minimum 2.0 Amps). Service disconnect stations must be listed with the appropriate agencies in your area. See *Listing agencies*.

Releasing solenoid valves. Releasing solenoid valves must be listed with the appropriate agencies in your area. See *Listing agencies*.

Listing agencies. Listing agencies include:

- Factory Mutual Research Corporation (FMRC)
- Underwriters Laboratories, Inc. (UL)
- Underwriters Laboratories Canada (ULC)

Switch Settings

Abort mode and time delay settings are configured by means of dip switches on the module.

Abort mode

Mode	SW1	SW2	
1	0	0	Routines that determine how the abort function interacts with the timers.
2	0	1	
3	1	0	
4	1	1	

Manual time delay (seconds)

Delay	SW3	SW4	
0	0	0	The length of time that the deluge is inhibited when the releasing function is manually initiated.
10	0	1	
20	1	0	
30	1	1	

Automatic time delay (seconds)

Delay	SW5	SW6	SW7	
10	0	0	0	The length of time that the deluge is inhibited when the releasing function is initiated by the control panel (i.e.: after receiving an alarm).
20	0	0	1	
30	0	1	0	
40	0	1	1	
50	1	0	0	

Abort time delay (seconds)

Delay	SW8	
0	0	The length of time that the deluge is inhibited when the abort function is restored (i.e.: cancelled).
10	1	

Denotes default settings.

Wiring

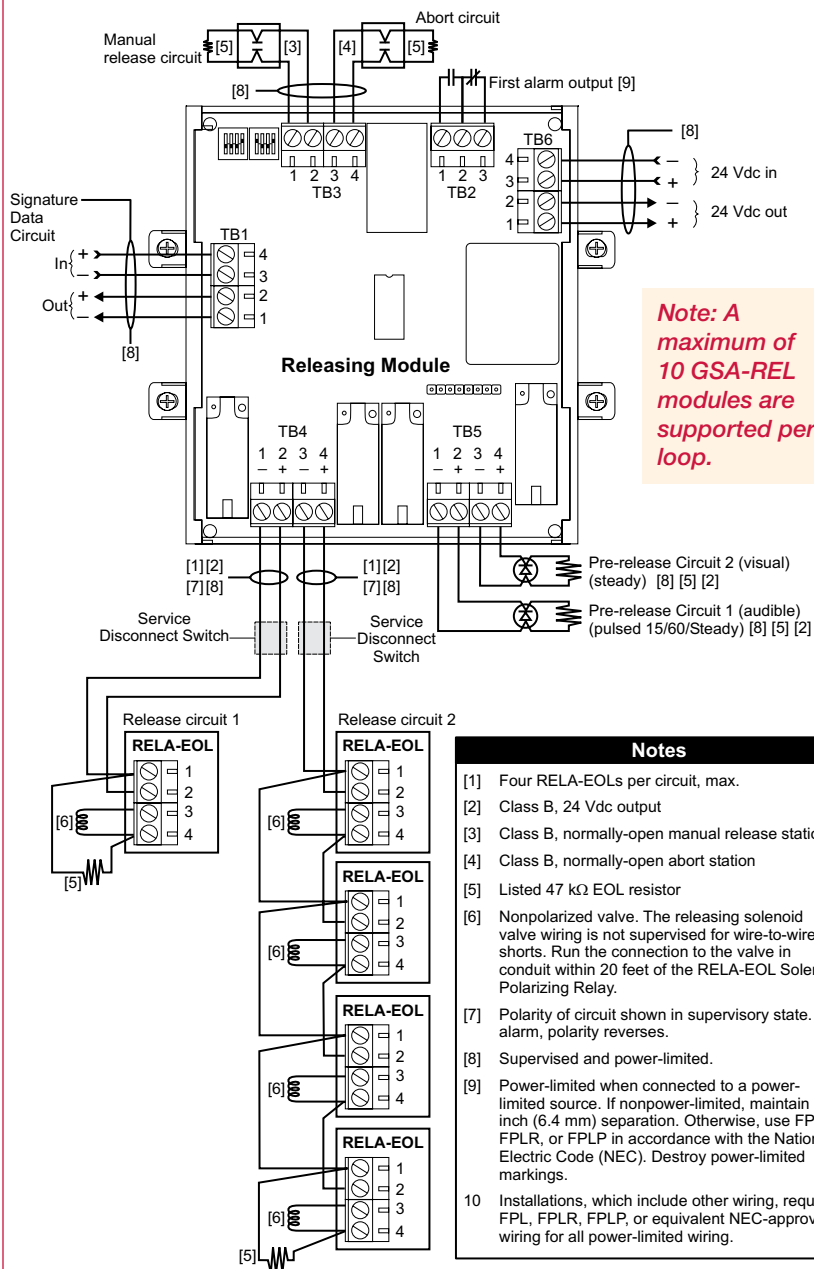

Note: A maximum of 10 GSA-REL modules are supported per loop.

Notes	
[1]	Four RELA-EOLs per circuit, max.
[2]	Class B, 24 Vdc output
[3]	Class B, normally-open manual release station
[4]	Class B, normally-open abort station
[5]	Listed 47 kΩ EOL resistor
[6]	Nonpolarized valve. The releasing solenoid valve wiring is not supervised for wire-to-wire shorts. Run the connection to the valve in conduit within 20 feet of the RELA-EOL Solenoid Polarizing Relay.
[7]	Polarity of circuit shown in supervisory state. On alarm, polarity reverses.
[8]	Supervised and power-limited.
[9]	Power-limited when connected to a power-limited source. If nonpower-limited, maintain 1/4 inch (6.4 mm) separation. Otherwise, use FPL, FPLR, or FPLP in accordance with the National Electric Code (NEC). Destroy power-limited markings.
[10]	Installations, which include other wiring, require FPL, FPLR, FPLP, or equivalent NEC-approved wiring for all power-limited wiring.

Mounting

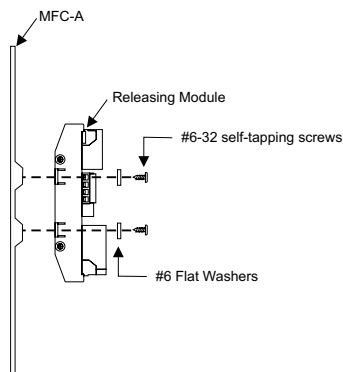

LED Operation

LED	Color	Pattern	Function
DS1	Red	Flashing	Data (alarm conditions)*
DS2	Green	Flashing	Data (normal conditions)*
DS3	Red	Steady	Alarm
DS4	Green	Steady	Power
DS5	Yellow	Steady	Abort
DS6	Yellow	Steady	Trouble
DS7	Red	Steady	Release Active

*Note: During a loss of communications, the Releasing Module will go into a standby condition, which will cause DS1 and DS2 to change to a steady pattern during an alarm condition.

Accessories

Typical application of GSA-REL accessories (computer room)

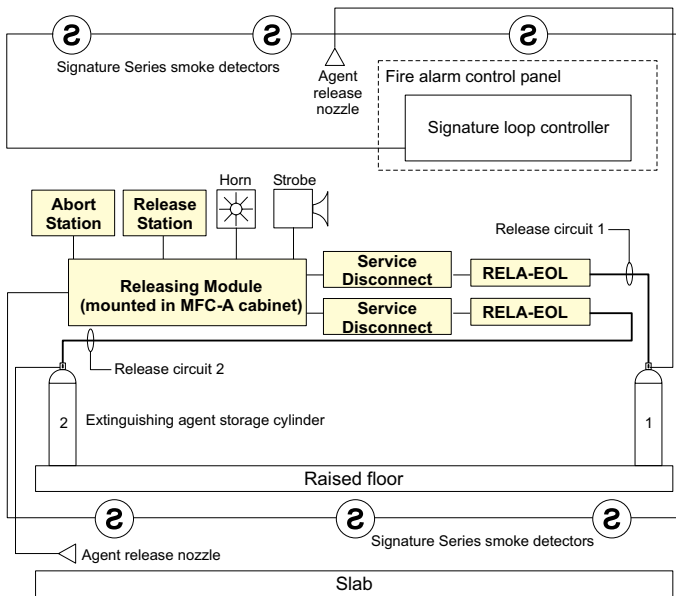

Manual Release Station

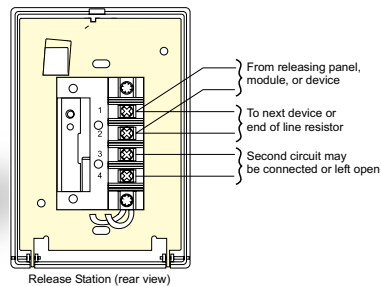

The manual release station is a normally-open, dry contact signal initiating device. The 276A-REL is a single-action station that requires the user to pull the release handle to initiate the release of a fire suppression agent. The 278A-REL (shown) is a double-action station that requires the user to raise the upper door, then pull the release handle to initiate the release.

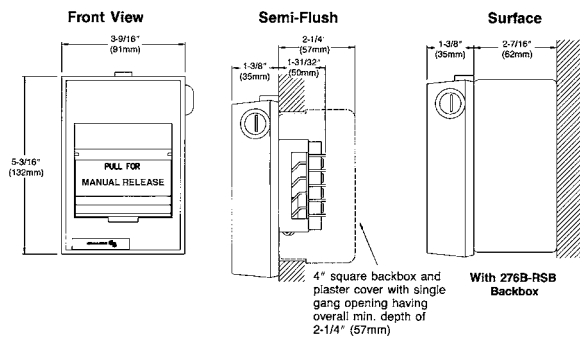

Abort Station

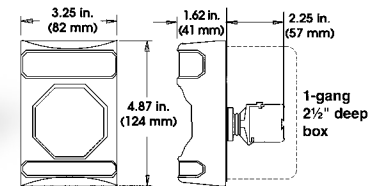

The abort station is a normally-open, non-latching device. It is used to prevent the release of agent into the protected area after the release sequence has begun.

Service Disconnect Switch

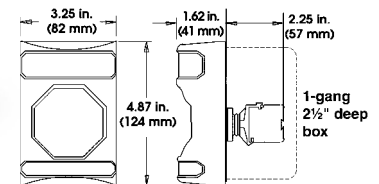

The service disconnect switch is used to temporarily disable the fire suppression system. One switch is installed on each of the two release circuits between the GSA-REL and the RELA-EOL end-of-line relay. Opening the Service Disconnect Switch allows the fire alarm system to be tested without activating the fire suppression system. The operation of this switch causes a trouble signal at the control panel.

End-of-Line Relay

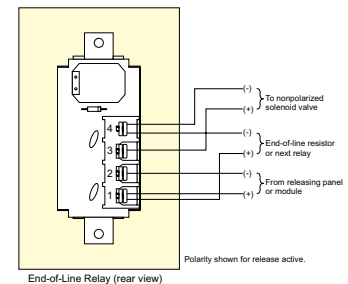
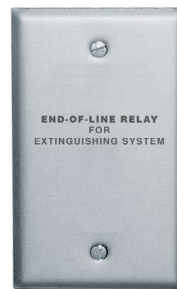

The End-of-Line Relay facilitates the connection of a non-polarized releasing solenoid to a supervised, polarized releasing circuit. One relay is required per release solenoid.

Module Enclosure

The MFC-A cabinet is UL-listed for use with Signature modules. Shown here with plug-in style I/O modules, the MFC-A also meets UL requirements for spacing and clearance around the GSA-REL Releasing Module. The cabinet features red epoxy finish with white "FIRE" markings.



Specifications

Power riser	Input voltage	24 Vdc (power limited)
	Supervisory current	25 mA, max.
	Riser input current	4 amps maximum
	Alarm	170 mA min.; 4 A max.
Release circuits	Output rating	2 A @ 24 Vdc (for each circuit)
	Valves per circuit	4 valves, max.
	Max. supervisory current	0.4 mA (short circuit)
	Nominal supervisory current	0.18 mA
	Supervisory voltage	26 Vdc, max. (open circuit)
	End of line device	47k Ohm EOL
Pre-release alarm circuits	Output rating	2 A @ 24 Vdc (for each circuit)
	Max. supervisory current	0.4 mA (short circuit)
	Nominal supervisory current	0.18 mA
	Supervisory voltage	26 Vdc, max. (open circuit)
	End of line device	47k Ohm resistor
Manual release input circuit	Max. supervisory current	0.4 mA (short circuit)
	Nominal supervisory current	0.18 mA
	Supervisory voltage	26 Vdc, max. (open circuit)
	End of line device	47k Ohm resistor
	Circuit type	Class B N.O. latching
Abort circuit	Circuit capacitance	0.1 µF, max
	Max. supervisory current	0.4 mA (short circuit)
	Nominal supervisory current	0.18 mA
	Supervisory voltage	26 Vdc, max. (open circuit)
	End of line device	47k Ohm resistor
First alarm output relay	Circuit type	Class B N.O. non- latching
	Circuit capacitance	0.1 µF, max
	Contact rating	3 A @ 24 Vdc (0.6 power factor) Form C
Signature Data line	Operating voltage	5.2 to 19.95 Vdc
	Supervisory current	1000 µA
	Alarm current	1000 µA
Environmental conditions	Operating temperature	32° F to 120° F (0° C to 49° C)
	Storage temperature	-4° F to 140° F (-20° C to 60° C)
	Humidity	0 to 93% Non-condensing
Wiring Terminals	Suitable for #18 to #12 AWG (2.5 mm ² to .75 mm ²)	
Type Code	Factory Set	
Addressing Requirements	Uses six module addresses	
Agency Listings	UL, ULC, and FM	
Compatible Solenoids	Must be both UL/ULC-listed and FM-approved	

Note: Output circuits are power-limited when the riser circuit is power-limited.

Line Resistance

Power riser

Total riser current (Amps)	Distance from GSA-REL to power supply				Wire resistance (Ohms per wire)
	#12 AWG	2.5 mm ²	#14 AWG	1.5 mm ²	
4.0	29 ft	8.84 m	20 ft	6.10 m	0.050
3.5	34 ft	10.36 m	23 ft	7.01 m	0.057
3.0	39 ft	11.89 m	27 ft	8.23 m	0.067
2.5	47 ft	14.33 m	32 ft	9.75 m	0.080
2.0	59 ft	17.98 m	40 ft	12.19 m	0.100
1.5	78 ft	23.77 m	53 ft	16.15 m	0.133
1.0	118 ft	35.97 m	80 ft	24.38 m	0.200

Pre-release and release circuits (per circuit)

Total riser current (Amps)	Distance from GSA-REL to power supply				Wire resistance (Ohms per wire)
	#12 AWG	2.5 mm ²	#14 AWG	1.5 mm ²	
2.00	176 ft	53.64 m	120 ft	36.58 m	0.300
1.75	202 ft	61.57 m	137 ft	41.76 m	0.343
1.50	235 ft	71.63 m	160 ft	48.77 m	0.400
1.25	282 ft	85.95 m	192 ft	58.52 m	0.480
1.0	353 ft	107.59 m	240 ft	73.15 m	0.600
0.50	706 ft	215.19 m	480 ft	146.30 m	1.200

Ordering Information

Model	Description	Ship Wt. lb (kg)
GSA-REL	Analog addressable releasing module	0.52 (0.23)
276A-REL	Manual releasing station (single-action). English markings, black text on yellow polycarbonate body.	1.0 (0.45)
278A-REL	Manual releasing station (double-action). English markings, black text on yellow polycarbonate body.	1.0 (0.45)
RELA-ABT	Manual Abort Station. English markings, black text on yellow polycarbonate body.	1.0 (0.45)
RELA-SRV-1	Service Disconnect Switch. One n/c contact and one n/o contact. English markings, white text on blue polycarbonate body.	1.0 (0.45)
RELA-EOL	Polarized end-of-line relay. English markings on stainless steel cover.	0.2 (0.1)
MFC-A	UL listed cabinet for mounting releasing modules, red with white "FIRE". HWD: 8" x 14" x 3½" (203mm x 356mm x 89mm)	7.0 (3.1)



Technology that saves lives

Contact us

Phone: 888.244.9979 (Option 4)

Email: kidde.fire@carrier.com

Website: kidde-esfire.com

Kidde is a Carrier brand.
8985 Town Center Pkwy,
Bradenton, FL 34202

© 2020 Carrier
All rights reserved.
